

Inspiron 14 3000 Service Manual

Computer Model: Inspiron 14-3451
Regulatory Model: P60G
Regulatory Type: P60G002



Notes, cautions, and warnings



NOTE: A NOTE indicates important information that helps you make better use of your product.



CAUTION: A CAUTION indicates either potential damage to hardware or loss of data and tells you how to avoid the problem.



WARNING: A WARNING indicates a potential for property damage, personal injury, or death.

Copyright © 2016 Dell Inc. or its subsidiaries. All rights reserved. Dell, EMC, and other trademarks are trademarks of Dell Inc. or its subsidiaries. Other trademarks may be trademarks of their respective owners.

2016 - 08

Rev. A01

Contents

Before working inside your computer.....	10
Before you begin	10
Safety instructions.....	10
Recommended tools.....	11
After working inside your computer.....	13
Removing the battery.....	14
Procedure.....	14
Replacing the battery.....	15
Procedure.....	15
Removing the base cover.....	16
Prerequisites.....	16
Procedure.....	16
Replacing the base cover.....	18
Procedure.....	18
Post-requisites.....	18
Removing the hard drive.....	19
Prerequisites.....	19
Procedure.....	19
Replacing the hard drive.....	22
Procedure.....	22
Post-requisites.....	22



Removing the memory modules.....	23
Prerequisites.....	23
Procedure.....	23
Replacing the memory modules.....	25
Procedure.....	25
Post-requisites.....	26
Removing the wireless card.....	27
Prerequisites.....	27
Procedure.....	27
Replacing the wireless card.....	29
Procedure.....	29
Post-requisites.....	29
Removing the keyboard.....	30
Prerequisites.....	30
Procedure.....	30
Replacing the keyboard.....	33
Procedure.....	33
Post-requisites.....	33
Removing the palm rest.....	34
Prerequisites.....	34
Procedure.....	34
Replacing the palm rest.....	39
Procedure.....	39
Post-requisites.....	39



Removing the touch pad.....	40
Prerequisites.....	40
Procedure.....	40
Replacing the touch pad.....	43
Procedure.....	43
Post-requisites.....	43
Removing the power-button board.....	44
Prerequisites.....	44
Procedure.....	44
Replacing the power-button board.....	46
Procedure.....	46
Post-requisites.....	46
Removing the speakers.....	47
Prerequisites.....	47
Procedure.....	47
Replacing the speakers.....	49
Procedure.....	49
Post-requisites.....	49
Removing the I/O board.....	50
Prerequisites.....	50
Procedure.....	50
Replacing the I/O board.....	52
Procedure.....	52
Post-requisites.....	52



Removing the system board.....	53
Prerequisites.....	53
Procedure.....	53
Replacing the system board.....	56
Procedure.....	56
Post-requisites.....	56
Removing the coin-cell battery.....	58
Prerequisites.....	58
Procedure.....	58
Replacing the coin-cell battery.....	60
Procedure.....	60
Post-requisites.....	60
Removing the thermal-cooling assembly.....	61
Prerequisites.....	61
Procedure.....	61
Replacing the thermal-cooling assembly.....	63
Procedure.....	63
Post-requisites.....	63
Removing the fan.....	64
Prerequisites.....	64
Procedure.....	64
Replacing the fan.....	66
Procedure.....	66
Post-requisites.....	66



Removing the display assembly.....	67
Prerequisites.....	67
Procedure.....	67
Replacing the display assembly.....	72
Procedure.....	72
Post-requisites.....	72
Removing the display bezel.....	73
Prerequisites.....	73
Procedure.....	73
Replacing the display bezel.....	75
Procedure.....	75
Post-requisites.....	75
Removing the display panel.....	76
Prerequisites.....	76
Procedure.....	76
Replacing the display panel.....	79
Procedure.....	79
Post-requisites.....	79
Removing the display hinges.....	80
Prerequisites.....	80
Procedure.....	80
Replacing the display hinges.....	82
Procedure.....	82
Post-requisites.....	82



Removing the display back-cover.....	83
Prerequisites.....	83
Procedure.....	83
Replacing the display back-cover.....	85
Procedure.....	85
Post-requisites.....	85
Removing the camera.....	86
Prerequisites.....	86
Procedure.....	86
Replacing the camera.....	88
Procedure.....	88
Post-requisites.....	88
Removing the power-adapter port.....	89
Prerequisites.....	89
Procedure.....	89
Replacing the power-adapter port.....	91
Procedure.....	91
Post-requisites.....	91
Removing the computer base.....	92
Prerequisites.....	92
Procedure.....	92
Replacing the computer base.....	94
Procedure.....	94
Post-requisites.....	94



Flashing the BIOS..... 95

Getting help and contacting Dell..... 96

 Self-help resources..... 96

 Contacting Dell..... 97



Before working inside your computer



NOTE: The images in this document may differ from your computer depending on the configuration you ordered.

Before you begin

- 1 Save and close all open files and exit all open applications.
- 2 Shut down your computer.

The shut-down instruction varies depending on the operating system installed on your computer.

- Windows 10: Click **Start** →  **Power** → **Shut down**.
- Windows 8.1: On the **Start** screen, click the power icon  → **Shut down**.
- Windows 7: Click **Start** → **Shut down**.











NOTE: If you are using a different operating system, see the documentation of your operating system for shut-down instructions.

- 3 Disconnect your computer and all attached devices from their electrical outlets.
- 4 Disconnect all attached network devices and peripherals, such as keyboard, mouse, and monitor from your computer.
- 5 Remove any media card and optical disc from your computer, if applicable.
- 6 After the computer is unplugged, press and hold the power button for 5 seconds to ground the system board.

Safety instructions

Use the following safety guidelines to protect your computer from potential damage and ensure your personal safety.

-  **WARNING:** Before working inside your computer, read the safety information that shipped with your computer. For more safety best practices, see the Regulatory Compliance home page at www.dell.com/regulatory_compliance.
-  **WARNING:** Disconnect all power sources before opening the computer cover or panels. After you finish working inside the computer, replace all covers, panels, and screws before connecting to the electrical outlet.
-  **CAUTION:** To avoid damaging the computer, ensure that the work surface is flat and clean.
-  **CAUTION:** To avoid damaging the components and cards, handle them by their edges, and avoid touching pins and contacts.
-  **CAUTION:** You should only perform troubleshooting and repairs as authorized or directed by the Dell technical assistance team. Damage due to servicing that is not authorized by Dell is not covered by your warranty. See the safety instructions that shipped with the product or at www.dell.com/regulatory_compliance.
-  **CAUTION:** Before touching anything inside your computer, ground yourself by touching an unpainted metal surface, such as the metal at the back of the computer. While you work, periodically touch an unpainted metal surface to dissipate static electricity, which could harm internal components.
-  **CAUTION:** When you disconnect a cable, pull on its connector or on its pull tab, not on the cable itself. Some cables have connectors with locking tabs or thumb-screws that you must disengage before disconnecting the cable. When disconnecting cables, keep them evenly aligned to avoid bending any connector pins. When connecting cables, ensure that the ports and connectors are correctly oriented and aligned.
-  **CAUTION:** Press and eject any installed card from the media-card reader.

Recommended tools

The procedures in this document may require the following tools:

- Phillips screwdriver



- Plastic scribe



After working inside your computer



CAUTION: Leaving stray or loose screws inside your computer may severely damage your computer.

- 1 Replace all screws and ensure that no stray screws remain inside your computer.
- 2 Connect any external devices, peripherals, or cables you removed before working on your computer.
- 3 Replace any media cards, discs, or any other parts that you removed before working on your computer.
- 4 Connect your computer and all attached devices to their electrical outlets.
- 5 Turn on your computer.



Removing the battery

⚠ WARNING: Before working inside your computer, read the safety information that shipped with your computer and follow the steps in [Before working inside your computer](#). After working inside your computer, follow the instructions in [After working inside your computer](#). For more safety best practices, see the Regulatory Compliance home page at www.dell.com/regulatory_compliance.

Procedure

- 1 Close the display and turn the computer over.
- 2 Slide the battery-release latch to the unlock position.
- 3 Lift the battery at an angle and remove the battery from the battery bay.

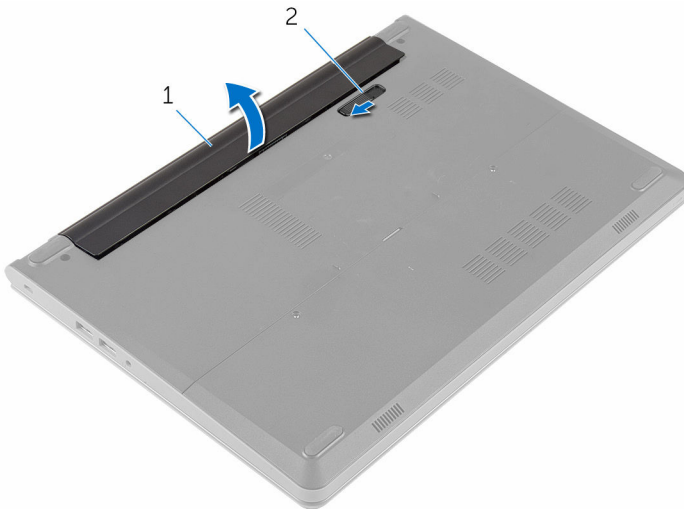

1 battery

2 battery-release latch

- 4 Turn the computer over and open the display.
- 5 Press and hold the power button for 5 seconds to ground the system board.

Replacing the battery



WARNING: Before working inside your computer, read the safety information that shipped with your computer and follow the steps in [Before working inside your computer](#). After working inside your computer, follow the instructions in [After working inside your computer](#). For more safety best practices, see the Regulatory Compliance home page at www.dell.com/regulatory_compliance.

Procedure

- 1 Close the display and turn the computer over.
- 2 Place the battery in the battery bay and snap the battery into place.



NOTE: Ensure that the battery-release latch is secured.



Removing the base cover



WARNING: Before working inside your computer, read the safety information that shipped with your computer and follow the steps in [Before working inside your computer](#). After working inside your computer, follow the instructions in [After working inside your computer](#). For more safety best practices, see the Regulatory Compliance home page at www.dell.com/regulatory_compliance.

Prerequisites

Remove the [battery](#).

Procedure

- 1 Remove the screws that secure the base cover to the computer base.

- 2** Using your fingertips, gently pry the base cover and remove it from the computer base.

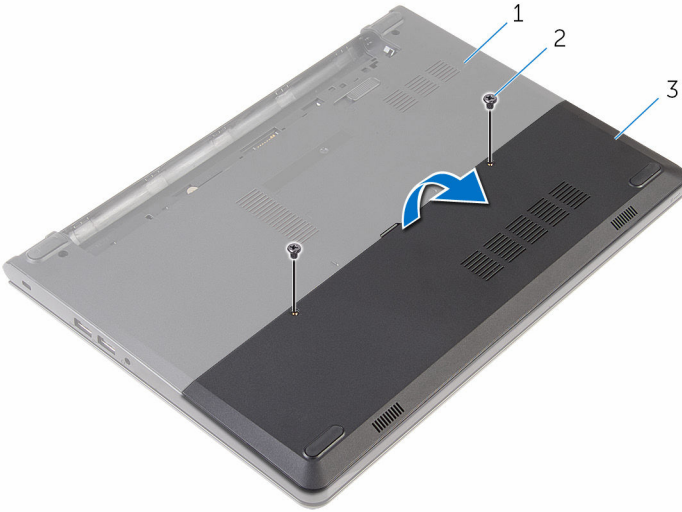

- 1 computer base
3 base cover

- 2 screws (2)



Replacing the base cover



WARNING: Before working inside your computer, read the safety information that shipped with your computer and follow the steps in [Before working inside your computer](#). After working inside your computer, follow the instructions in [After working inside your computer](#). For more safety best practices, see the Regulatory Compliance home page at www.dell.com/regulatory_compliance.

Procedure

- 1 Slide the tabs on the base cover into the slots on the computer base and snap the base cover into place.
- 2 Replace the screws that secure the base cover to the computer base.

Post-requisites

Replace the [battery](#).

Removing the hard drive

 **WARNING:** Before working inside your computer, read the safety information that shipped with your computer and follow the steps in [Before working inside your computer](#). After working inside your computer, follow the instructions in [After working inside your computer](#). For more safety best practices, see the Regulatory Compliance home page at www.dell.com/regulatory_compliance.

 **CAUTION:** Hard drives are fragile. Exercise care when handling the hard drive.

 **CAUTION:** To avoid data loss, do not remove the hard drive while the computer is in sleep or on state.

Prerequisites

- 1 Remove the [battery](#).
- 2 Remove the [base cover](#).

Procedure

- 1 Remove the screws that secure the hard-drive assembly to the computer base.
- 2 Lift the latch and disconnect the hard-drive cable from the system board.



- 3** Lift the hard-drive assembly off the computer base.

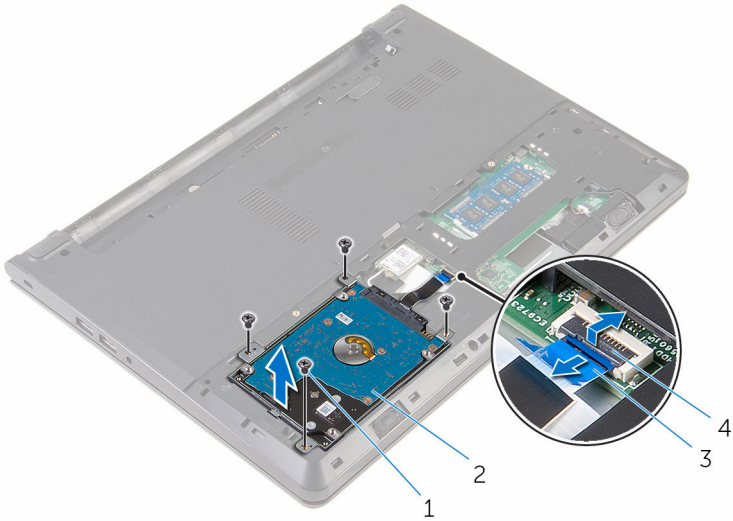

- | | | | |
|---|------------------|---|---------------------|
| 1 | screws (4) | 2 | hard-drive assembly |
| 3 | hard-drive cable | 4 | latch |

- 4** Remove the screws that secure the hard-drive bracket to the hard-drive assembly.
- 5** Lift the hard-drive bracket off the hard-drive assembly.

6 Disconnect the interposer from the hard drive.

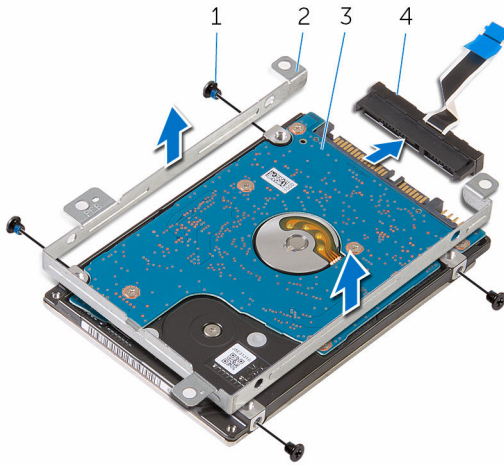

- 1 screws (4)
- 3 hard drive

- 2 hard-drive bracket
- 4 interposer

Replacing the hard drive



WARNING: Before working inside your computer, read the safety information that shipped with your computer and follow the steps in [Before working inside your computer](#). After working inside your computer, follow the instructions in [After working inside your computer](#). For more safety best practices, see the Regulatory Compliance home page at www.dell.com/regulatory_compliance.



CAUTION: Hard drives are fragile. Exercise care when handling the hard drive.

Procedure

- 1 Connect the interposer to the hard drive.
- 2 Align the screw holes on the hard-drive bracket with the screw holes on the hard-drive assembly.
- 3 Replace the screws that secure the hard-drive bracket to the hard-drive assembly.
- 4 Align the screw holes on the hard-drive assembly with the screw holes on the computer base.
- 5 Replace the screws that secure the hard-drive assembly to the computer base.
- 6 Slide the hard-drive cable into the system board and press down on the latch to secure the cable.

Post-requisites

- 1 Replace the [base cover](#).
- 2 Replace the [battery](#).

Removing the memory modules



WARNING: Before working inside your computer, read the safety information that shipped with your computer and follow the steps in [Before working inside your computer](#). After working inside your computer, follow the instructions in [After working inside your computer](#). For more safety best practices, see the Regulatory Compliance home page at www.dell.com/regulatory_compliance.

Prerequisites

- 1 Remove the [battery](#).
- 2 Remove the [base cover](#).

Procedure

- 1 Using your fingertips, pry apart the securing clips on each end of the memory-module slot until the memory module pops up.



- 2 Slide and remove the memory module from the memory-module slot.

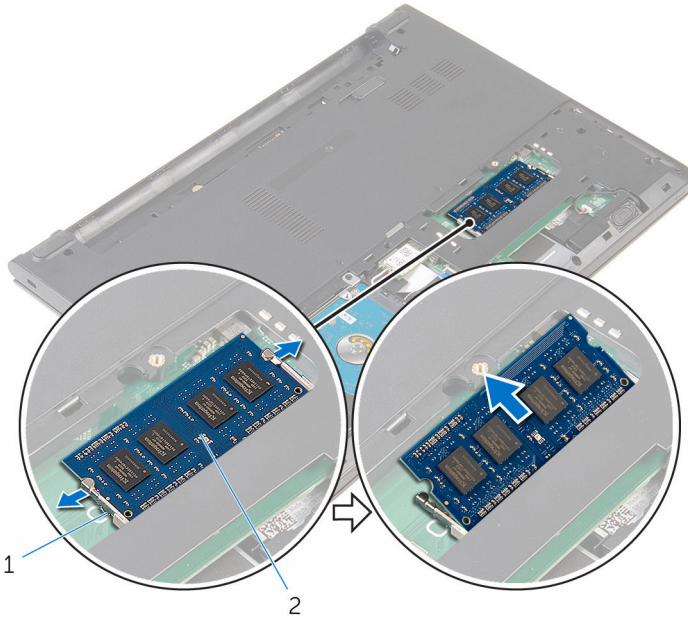

1 securing clips (2)

2 memory module

Replacing the memory modules



WARNING: Before working inside your computer, read the safety information that shipped with your computer and follow the steps in [Before working inside your computer](#). After working inside your computer, follow the instructions in [After working inside your computer](#). For more safety best practices, see the Regulatory Compliance home page at www.dell.com/regulatory_compliance.

Procedure

- 1 Align the notch on the memory module with the tab on the memory-module slot.



- Slide the memory module firmly into the slot at an angle and press the memory module down until it clicks into place.

 **NOTE: If you do not hear the click, remove the memory module and reinstall it.**

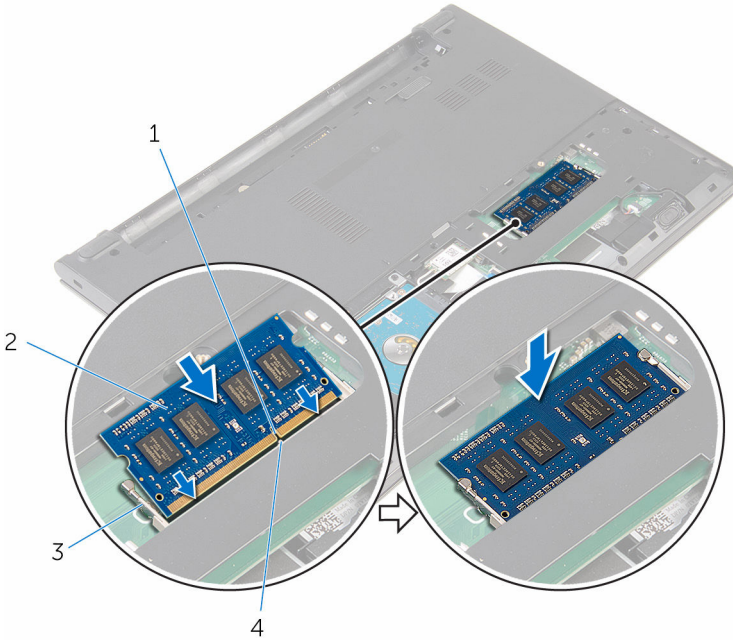

- 1 notch
- 3 securing clips (2)

- 2 memory module
- 4 tab

Post-requisites

- Replace the [base cover](#).
- Replace the [battery](#).

Removing the wireless card



WARNING: Before working inside your computer, read the safety information that shipped with your computer and follow the steps in [Before working inside your computer](#). After working inside your computer, follow the instructions in [After working inside your computer](#). For more safety best practices, see the Regulatory Compliance home page at www.dell.com/regulatory_compliance.

Prerequisites

- 1 Remove the [battery](#).
- 2 Remove the [base cover](#).

Procedure

- 1 Disconnect the antenna cables from the wireless card.
- 2 Remove the screw that secures the wireless card to the system board.



3 Slide and lift the wireless card off the wireless-card slot.

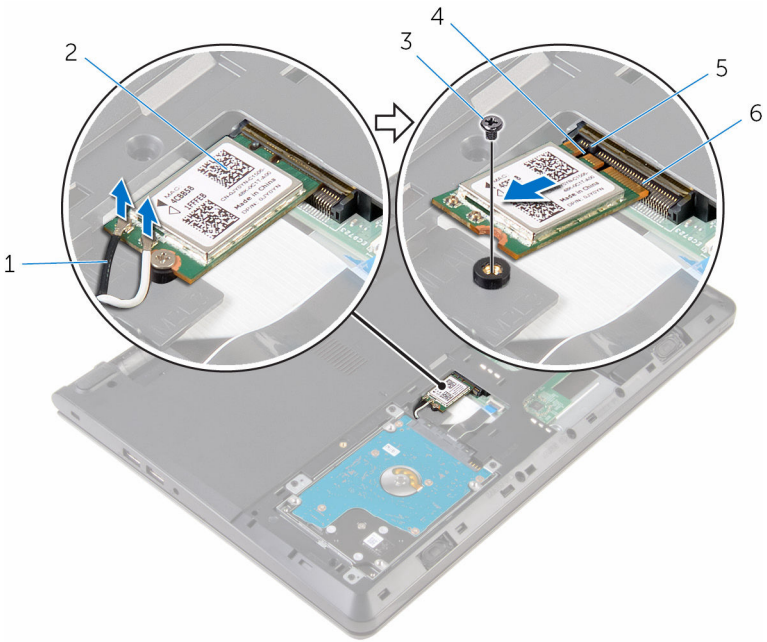

1 antenna cables (2)

3 screw

5 tab

2 wireless card

4 notch

6 wireless-card slot

Replacing the wireless card

 **WARNING:** Before working inside your computer, read the safety information that shipped with your computer and follow the steps in [Before working inside your computer](#). After working inside your computer, follow the instructions in [After working inside your computer](#). For more safety best practices, see the Regulatory Compliance home page at www.dell.com/regulatory_compliance.

Procedure

 **CAUTION:** To avoid damaging the wireless card, do not place any cables under it.

- 1 Align the notch on the wireless card with the tab on the wireless-card slot and slide the card into the slot.
- 2 Press the other end of the wireless card and replace the screw that secures the wireless card to the system board.
- 3 Connect the antenna cables to the wireless card.

Table 1. Antenna-cable color scheme

Connectors on the wireless card	Antenna-cable color
Main (white triangle)	White
Auxiliary (black triangle)	Black

Post-requisites

- 1 Replace the [base cover](#).
- 2 Replace the [battery](#).



Removing the keyboard



WARNING: Before working inside your computer, read the safety information that shipped with your computer and follow the steps in [Before working inside your computer](#). After working inside your computer, follow the instructions in [After working inside your computer](#). For more safety best practices, see the Regulatory Compliance home page at www.dell.com/regulatory_compliance.

Prerequisites

Remove the [battery](#).

Procedure

- 1 Using a plastic scribe, gently release the tabs that secure the keyboard to the palm-rest assembly.

2 Carefully turn the keyboard over and place it on the palm-rest assembly.



1 tabs (5)

2 plastic scribe

3 keyboard

4 palm-rest assembly

3 Lift the latch and disconnect the keyboard cable from the system board.



- 4 Lift the keyboard along with the cable off the palm-rest assembly.

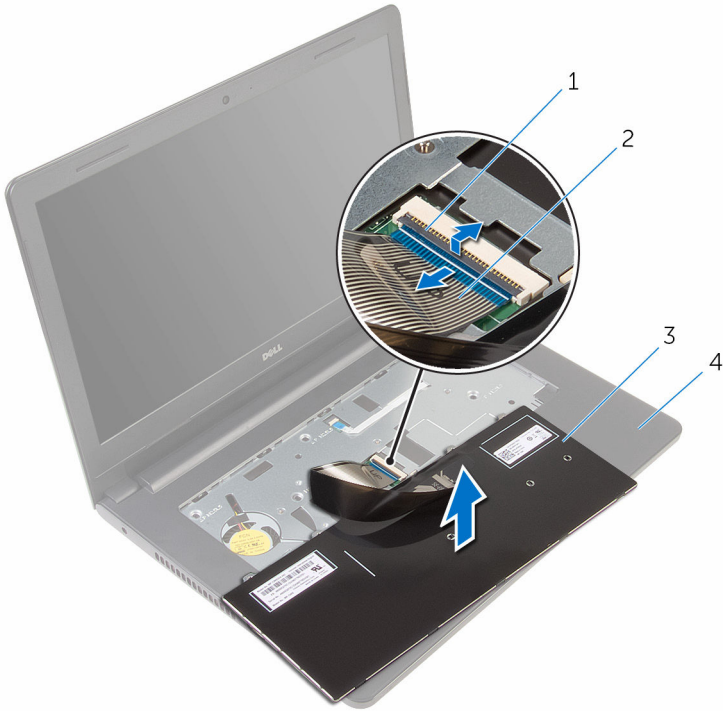

- 1 latch
3 keyboard

- 2 keyboard cable
4 palm-rest assembly

Replacing the keyboard



WARNING: Before working inside your computer, read the safety information that shipped with your computer and follow the steps in [Before working inside your computer](#). After working inside your computer, follow the instructions in [After working inside your computer](#). For more safety best practices, see the Regulatory Compliance home page at www.dell.com/regulatory_compliance.

Procedure

- 1 Slide the keyboard cable into the system board and press down on the latch to secure the cable.
- 2 Carefully turn the keyboard over, slide the tabs on the keyboard into the slots on the palm-rest assembly, and snap the keyboard into place.

Post-requisites

Replace the [battery](#).



Removing the palm rest



WARNING: Before working inside your computer, read the safety information that shipped with your computer and follow the steps in [Before working inside your computer](#). After working inside your computer, follow the instructions in [After working inside your computer](#). For more safety best practices, see the Regulatory Compliance home page at www.dell.com/regulatory_compliance.

Prerequisites

- 1 Remove the [battery](#).
- 2 Remove the [base cover](#).
- 3 Follow the procedure from step 1 to step 3 in "[Removing the hard drive](#)".
- 4 Remove the [keyboard](#).

Procedure

- 1 Remove the screws that secure the palm-rest assembly to the computer base.

- 2 Lift the latches and disconnect the touch-pad cable and power-button cable from the system board.

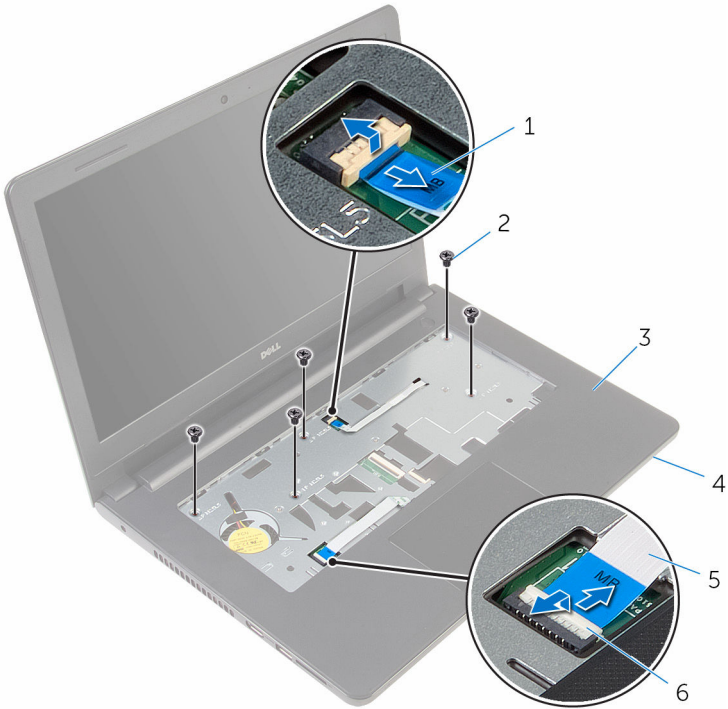

- | | | | |
|---|--------------------|---|---------------|
| 1 | power-button cable | 2 | screws (5) |
| 3 | palm-rest assembly | 4 | computer base |
| 5 | touch-pad cable | 6 | latches (2) |

- 3 Close the display and turn the computer over.
- 4 Remove the screws that secure the palm-rest assembly to the computer base.



5 Disconnect the speaker cable from the system board.

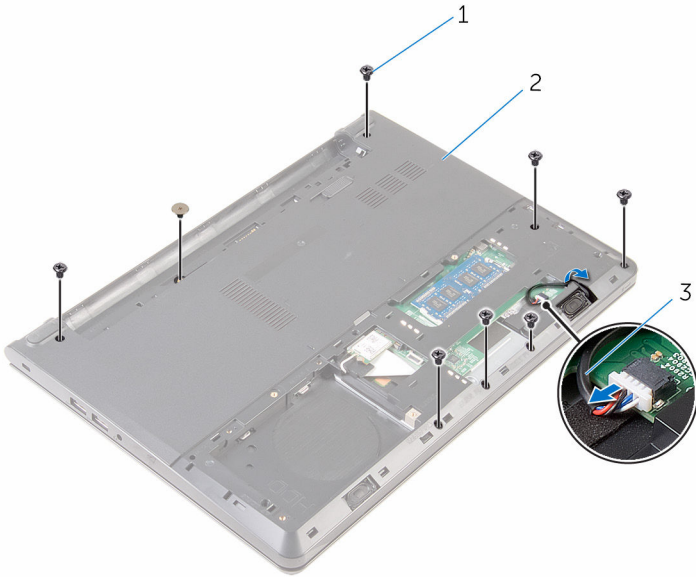

1 screws (8)

2 computer base

3 speaker cable

- 6** Lift the computer base and pry the palm-rest assembly off the computer base using a plastic scribe.

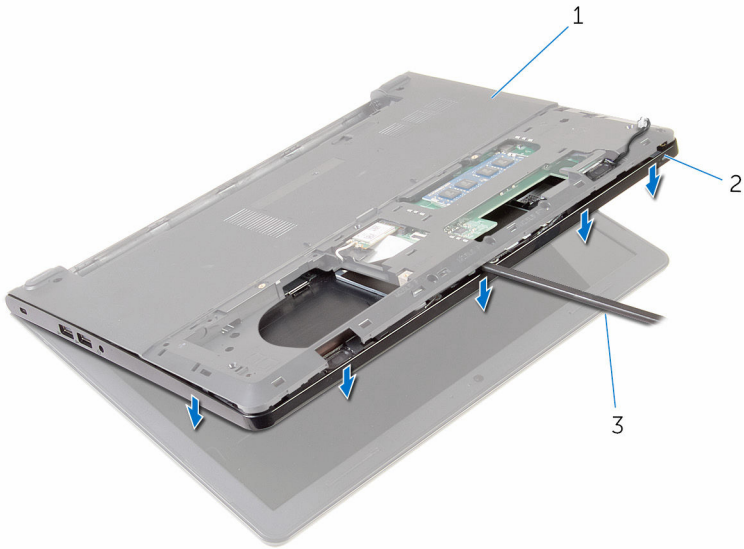

1 computer base
3 plastic scribe

2 palm-rest assembly

- 7** Turn the computer over and open the display as far as possible.



- 8 Lift the palm-rest assembly at an angle and remove it from the computer base.



1 palm-rest assembly

2 computer base

- 9 Follow the procedure from step 1 to step 6 in [“Removing the touch pad”](#).
- 10 Follow the procedure from step 1 to step 4 in [“Removing the power-button board”](#).
- 11 Follow the procedure from step 1 to step 4 in [“Removing the speakers”](#).

Replacing the palm rest



WARNING: Before working inside your computer, read the safety information that shipped with your computer and follow the steps in [Before working inside your computer](#). After working inside your computer, follow the instructions in [After working inside your computer](#). For more safety best practices, see the Regulatory Compliance home page at www.dell.com/regulatory_compliance.

Procedure

- 1 Follow the procedure from step 1 to step 3 in "[Replacing the speakers](#)".
- 2 Follow the procedure from step 1 to step 4 in "[Replacing the power-button board](#)".
- 3 Follow the procedure from step 1 to step 5 in "[Replacing the touch pad](#)".
- 4 Slide the speaker cable through the slot on the computer base.
- 5 Align the screw holes on the palm-rest assembly with the screw holes on the computer base.
- 6 Replace the screws that secure the palm-rest assembly to the computer base.
- 7 Slide the touch-pad cable and the power-button cable into the system board and press down on the latches to secure the cables.
- 8 Close the display and turn the computer over.
- 9 Replace the screws that secure the palm-rest assembly to the computer base.
- 10 Connect the speaker cable to the system board.
- 11 Turn the computer over and open the display.

Post-requisites

- 1 Replace the [keyboard](#).
- 2 Follow the procedure from step 4 to step 6 in "[Replacing the hard drive](#)".
- 3 Replace the [base cover](#).
- 4 Replace the [battery](#).



Removing the touch pad



WARNING: Before working inside your computer, read the safety information that shipped with your computer and follow the steps in [Before working inside your computer](#). After working inside your computer, follow the instructions in [After working inside your computer](#). For more safety best practices, see the Regulatory Compliance home page at www.dell.com/regulatory_compliance.

Prerequisites

- 1 Remove the [battery](#).
- 2 Remove the [base cover](#).
- 3 Follow the procedure from step 1 to step 3 in "[Removing the hard drive](#)".
- 4 Remove the [keyboard](#).
- 5 Follow the procedure from step 1 to step 8 in "[Removing the palm rest](#)".

Procedure

- 1 Turn the palm-rest assembly over and keep it on a clean and flat surface.
- 2 Remove the screws that secure the touch-pad bracket to the touch pad.

- 3** Lift the touch-pad bracket off the palm-rest assembly.

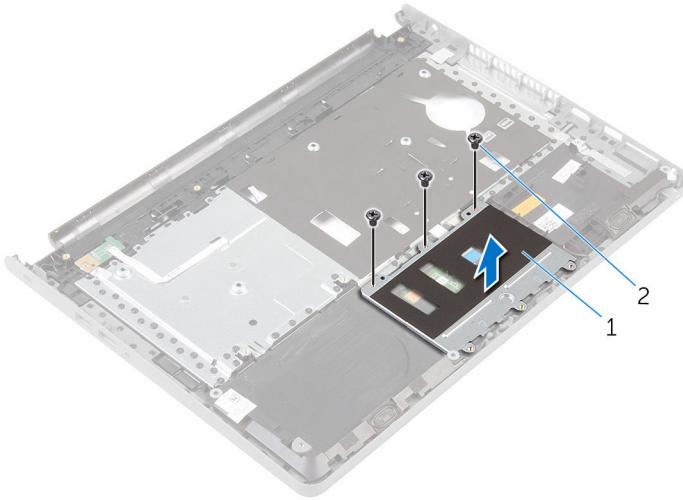

1 touch-pad bracket

2 screws (3)

- 4** Lift the latch and disconnect the touch-pad cable from the touch pad.
- 5** Peel off the tape that secures the touch pad to the palm-rest assembly.



6 Lift the touch pad off the palm-rest assembly.

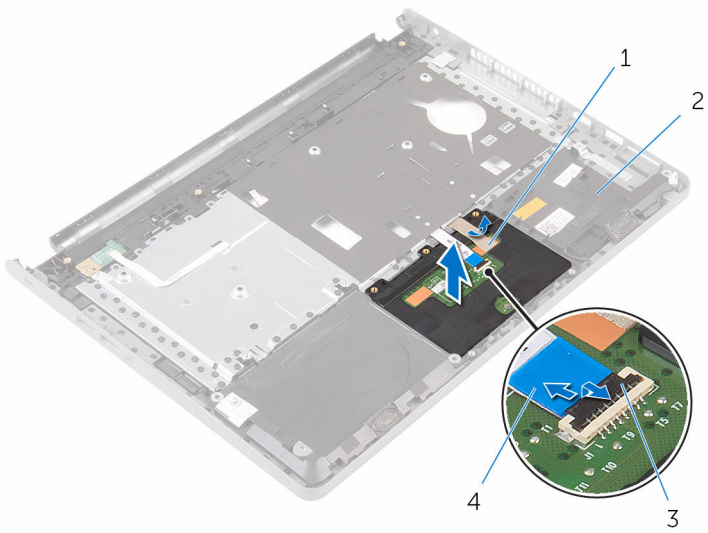

1 tape

3 latch

2 palm-rest assembly

4 touch-pad cable

Replacing the touch pad



WARNING: Before working inside your computer, read the safety information that shipped with your computer and follow the steps in [Before working inside your computer](#). After working inside your computer, follow the instructions in [After working inside your computer](#). For more safety best practices, see the Regulatory Compliance home page at www.dell.com/regulatory_compliance.

Procedure

- 1 Align the screw holes on the touch pad with the screw holes on the palm-rest assembly and keep the touch pad in place.
- 2 Adhere the tape that secures the touch pad to the palm-rest assembly.
- 3 Align the screw holes on the touch-pad bracket with the screw holes on the palm-rest assembly.
- 4 Replace the screws that secure the touch-pad bracket to the palm-rest assembly.
- 5 Turn the palm-rest assembly over.

Post-requisites

- 1 Follow the procedure from step 4 to step 11 in "[Replacing the palm rest](#)".
- 2 Replace the [keyboard](#).
- 3 Follow the procedure from step 4 to step 6 in "[Replacing the hard drive](#)".
- 4 Replace the [base cover](#).
- 5 Replace the [battery](#).



Removing the power-button board



WARNING: Before working inside your computer, read the safety information that shipped with your computer and follow the steps in [Before working inside your computer](#). After working inside your computer, follow the instructions in [After working inside your computer](#). For more safety best practices, see the Regulatory Compliance home page at www.dell.com/regulatory_compliance.

Prerequisites

- 1 Remove the [battery](#).
- 2 Remove the [base cover](#).
- 3 Follow the procedure from step 1 to step 3 in "[Removing the hard drive](#)".
- 4 Remove the [keyboard](#).
- 5 Follow the procedure from step 1 to step 8 in "[Removing the palm rest](#)".

Procedure

- 1 Turn the palm-rest assembly over and place it on a clean and flat surface.
- 2 Remove the power-button board cable through the slot on the palm-rest assembly.
- 3 Remove the screw that secures the power-button board to the palm-rest assembly.

- 4 Slide and remove the power-button board along with the cable from under the tab on the palm-rest assembly.

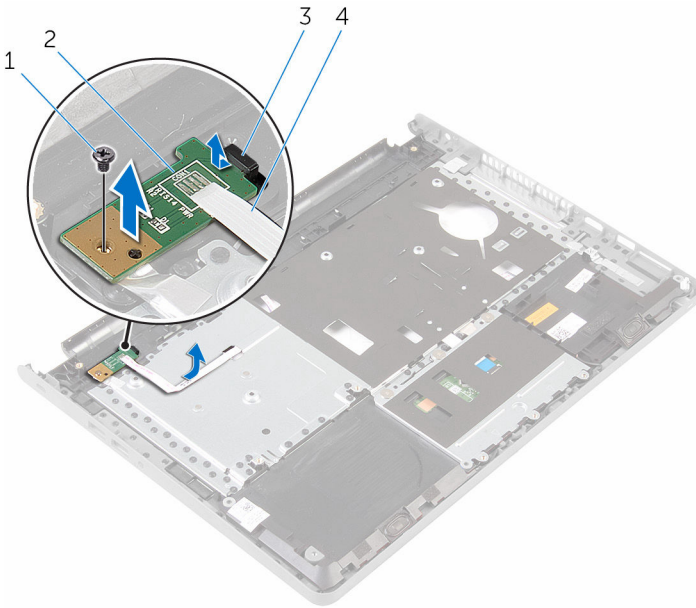

- 1 screw
3 tab

- 2 power-button board
4 power-button board cable



Replacing the power-button board



WARNING: Before working inside your computer, read the safety information that shipped with your computer and follow the steps in [Before working inside your computer](#). After working inside your computer, follow the instructions in [After working inside your computer](#). For more safety best practices, see the Regulatory Compliance home page at www.dell.com/regulatory_compliance.

Procedure

- 1 Slide the power-button board under the tab on the palm-rest assembly and align the screw hole on the power-button board with the screw hole on the palm-rest assembly.
- 2 Replace the screw that secures the power-button board to the palm-rest assembly.
- 3 Slide the power-button board cable through the slot on the palm-rest assembly.
- 4 Turn the palm-rest assembly over.

Post-requisites

- 1 Follow the procedure from step 4 to step 11 in "[Replacing the palm rest](#)".
- 2 Replace the [keyboard](#).
- 3 Follow the procedure from step 4 to step 6 in "[Replacing the hard drive](#)".
- 4 Replace the [base cover](#).
- 5 Replace the [battery](#).

Removing the speakers



WARNING: Before working inside your computer, read the safety information that shipped with your computer and follow the steps in [Before working inside your computer](#). After working inside your computer, follow the instructions in [After working inside your computer](#). For more safety best practices, see the Regulatory Compliance home page at www.dell.com/regulatory_compliance.

Prerequisites

- 1 Remove the [battery](#).
- 2 Remove the [base cover](#).
- 3 Follow the procedure from step 1 to step 3 in "[Removing the hard drive](#)".
- 4 Remove the [keyboard](#).
- 5 Follow the procedure from step 1 to step 8 in "[Removing the palm rest](#)".

Procedure

- 1 Turn the palm-rest assembly over and place it on a clean and flat surface.
- 2 Note the location of the speakers and pry the speakers off the palm-rest assembly.
- 3 Note the speaker-cable routing and remove the cable from the routing guides on the palm-rest assembly.



- 4 Lift the speakers along with the cable off the palm-rest assembly.

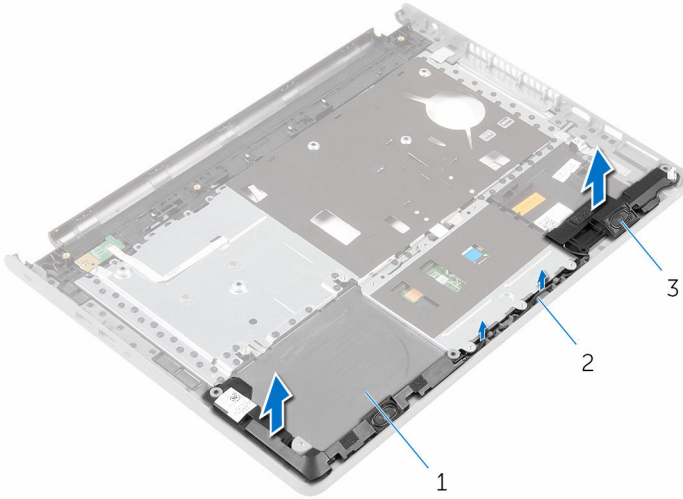

1 palm-rest assembly

2 speaker cable

3 speakers (2)

Replacing the speakers



WARNING: Before working inside your computer, read the safety information that shipped with your computer and follow the steps in [Before working inside your computer](#). After working inside your computer, follow the instructions in [After working inside your computer](#). For more safety best practices, see the Regulatory Compliance home page at www.dell.com/regulatory_compliance.

Procedure

- 1 Using the alignment posts, adhere the speakers to the palm-rest assembly.
- 2 Route the speaker cable through the routing guides on the palm-rest assembly.
- 3 Turn the palm-rest assembly over.

Post-requisites

- 1 Follow the procedure from step 4 to step 11 in "[Replacing the palm rest](#)".
- 2 Replace the [keyboard](#).
- 3 Follow the procedure from step 4 to step 6 in "[Replacing the hard drive](#)".
- 4 Replace the [base cover](#).
- 5 Replace the [battery](#).



Removing the I/O board



WARNING: Before working inside your computer, read the safety information that shipped with your computer and follow the steps in [Before working inside your computer](#). After working inside your computer, follow the instructions in [After working inside your computer](#). For more safety best practices, see the Regulatory Compliance home page at www.dell.com/regulatory_compliance.

Prerequisites

- 1 Remove the [battery](#).
- 2 Remove the [base cover](#).
- 3 Follow the procedure from step 1 to step 3 in "[Removing the hard drive](#)".
- 4 Remove the [keyboard](#).
- 5 Follow the procedure from step 1 to step 8 in "[Removing the palm rest](#)".

Procedure

- 1 Lift the latch and disconnect the I/O-board cable from the I/O board.
- 2 Remove the screw that secures the I/O board to the computer base.

3 Lift and slide the I/O board from under the tab on the computer base.

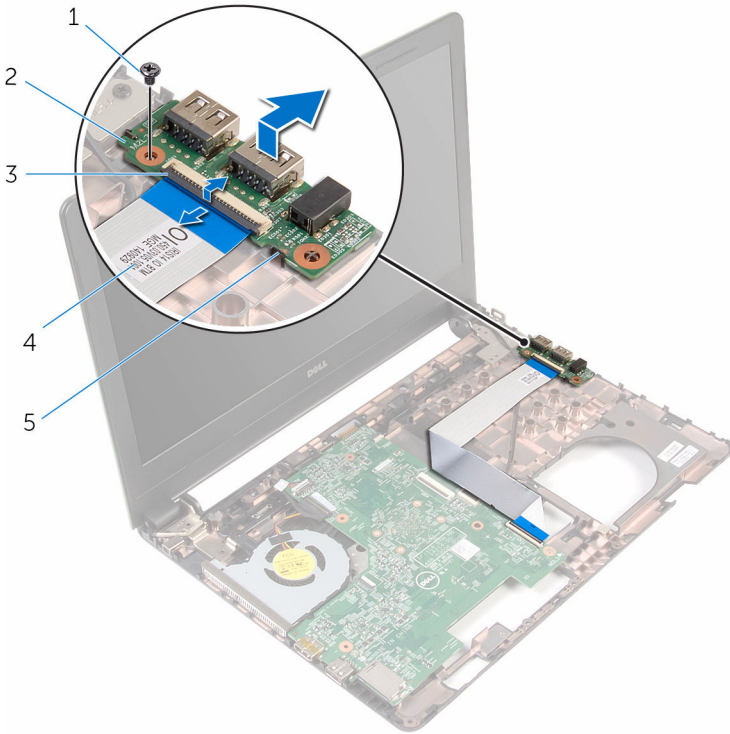

- 1 screw
- 3 latch
- 5 tab

- 2 I/O board
- 4 I/O-board cable



Replacing the I/O board



WARNING: Before working inside your computer, read the safety information that shipped with your computer and follow the steps in [Before working inside your computer](#). After working inside your computer, follow the instructions in [After working inside your computer](#). For more safety best practices, see the Regulatory Compliance home page at www.dell.com/regulatory_compliance.

Procedure

- 1 Slide the I/O board under the tab on the computer base and align the screw hole on the I/O board with the screw hole on the computer base.
- 2 Replace the screw that secures the I/O board to the computer base.
- 3 Slide the I/O-board cable into the I/O board and press down on the latch to secure the cable.

Post-requisites

- 1 Follow the procedure from step 4 to step 11 in "[Replacing the palm rest](#)".
- 2 Replace the [keyboard](#).
- 3 Follow the procedure from step 4 to step 6 in "[Replacing the hard drive](#)".
- 4 Replace the [base cover](#).
- 5 Replace the [battery](#).

Removing the system board



WARNING: Before working inside your computer, read the safety information that shipped with your computer and follow the steps in [Before working inside your computer](#). After working inside your computer, follow the instructions in [After working inside your computer](#). For more safety best practices, see the Regulatory Compliance home page at www.dell.com/regulatory_compliance.



NOTE: Your computer's Service Tag is stored in the system board. You must enter the Service Tag in the BIOS setup program after you replace the system board.



NOTE: Replacing the system board removes any changes you have made to the BIOS using the BIOS setup program. You must make the appropriate changes again after you replace the system board.



NOTE: Before disconnecting the cables from the system board, note the location of the connectors so that you can reconnect the cables correctly after you replace the system board.

Prerequisites

- 1 Remove the [battery](#).
- 2 Remove the [base cover](#).
- 3 Follow the procedure from step 1 to step 3 in "[Removing the hard drive](#)".
- 4 Remove the [memory modules](#).
- 5 Remove the [wireless card](#).
- 6 Remove the [keyboard](#).
- 7 Follow the procedure from step 1 to step 8 in "[Removing the palm rest](#)".

Procedure

- 1 Peel the tape that secures the display cable to the system board.
- 2 Lift the latches and disconnect the display cable and I/O-board cable from the system board.



- 3** Disconnect the power-adaptor port cable from the system board.

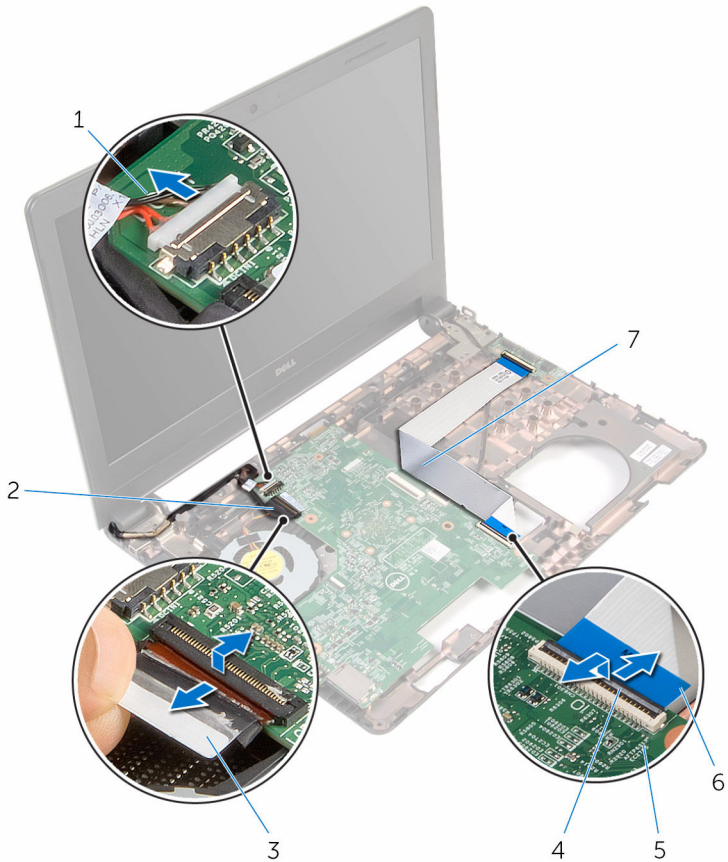

- 1 power-adaptor port cable
3 tape
5 system board

- 2 display cable
4 latches (2)
6 I/O-board cable

- 4** Remove the screw that secures the system board to the computer base.

- 5 Lift the system board off the computer base.

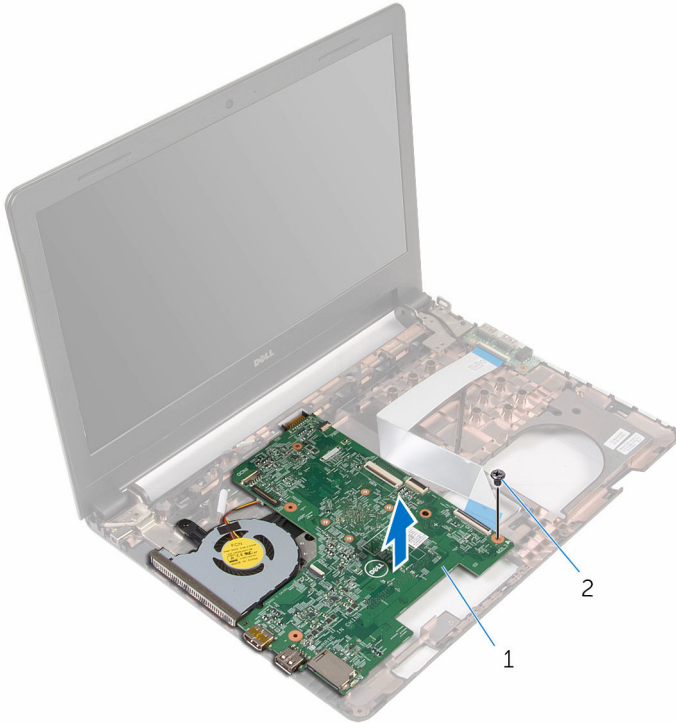

1 system board

2 screw

- 6 Turn the system board over.
- 7 Remove the [coin-cell battery](#).
- 8 Follow the procedure from step 1 to step 3 in "[Removing thermal-cooling assembly](#)".



Replacing the system board

 **WARNING:** Before working inside your computer, read the safety information that shipped with your computer and follow the steps in [Before working inside your computer](#). After working inside your computer, follow the instructions in [After working inside your computer](#). For more safety best practices, see the Regulatory Compliance home page at www.dell.com/regulatory_compliance.

 **NOTE:** Your computer's Service Tag is stored in the system board. You must enter the Service Tag in the BIOS setup program after you replace the system board.

 **NOTE:** Replacing the system board removes any changes you have made to the BIOS using the BIOS setup program. You must make the appropriate changes again after you replace the system board.

Procedure

- 1 Replace the [coin-cell battery](#).
- 2 Follow the procedure from step 2 to step 4 in "[Replacing the thermal-cooling assembly](#)".
- 3 Turn the system-board over.
- 4 Align the screw hole on the system board with the screw hole on the computer base.

 **CAUTION:** Ensure that no cables are placed under the system board.

- 5 Replace the screw that secures the system board to the computer base.
- 6 Connect the power-adaptor port cable to the system board.
- 7 Slide the display cable and I/O-board cable into the system board and press down on the latches to secure the cables.
- 8 Adhere the tape that secures the display cable to the system board.

Post-requisites

- 1 Follow the procedure from step 4 to step 11 in "[Replacing the palm rest](#)".

- 2 Replace the [keyboard](#).
- 3 Replace the [wireless card](#).
- 4 Replace the [memory modules](#).
- 5 Follow the procedure from step 4 to step 6 in "[Replacing the hard drive](#)".
- 6 Replace the [base cover](#).
- 7 Replace the [battery](#).



Removing the coin-cell battery

 **WARNING:** Before working inside your computer, read the safety information that shipped with your computer and follow the steps in [Before working inside your computer](#). After working inside your computer, follow the instructions in [After working inside your computer](#). For more safety best practices, see the Regulatory Compliance home page at www.dell.com/regulatory_compliance.

 **CAUTION:** Removing the coin-cell battery resets the BIOS setup program's settings to default. It is recommended that you note the BIOS setup program's settings before removing the coin-cell battery.

Prerequisites

- 1 Remove the [battery](#).
- 2 Remove the [base cover](#).
- 3 Follow the procedure from step 1 to step 3 in "[Removing the hard drive](#)".
- 4 Remove the [memory modules](#).
- 5 Remove the [wireless card](#).
- 6 Remove the [keyboard](#).
- 7 Follow the procedure from step 1 to step 8 in "[Removing the palm rest](#)".
- 8 Follow the procedure from step 1 to step 6 in "[Removing the system board](#)".

Procedure

Using a plastic scribe, gently pry out the coin-cell battery out of the battery socket.

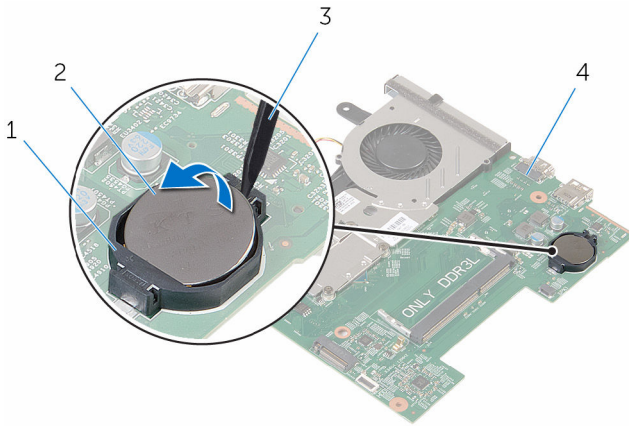

1 battery socket
3 plastic scribe

2 coin-cell battery
4 system board



Replacing the coin-cell battery



WARNING: Before working inside your computer, read the safety information that shipped with your computer and follow the steps in [Before working inside your computer](#). After working inside your computer, follow the instructions in [After working inside your computer](#). For more safety best practices, see the Regulatory Compliance home page at www.dell.com/regulatory_compliance.

Procedure

With the positive-side facing up, snap the coin-cell battery into the battery socket on the system board.

Post-requisites

- 1 Follow the procedure from step 3 to step 8 in "[Replacing the system board](#)".
- 2 Follow the procedure from step 4 to step 11 in "[Replacing the palm rest](#)".
- 3 Replace the [keyboard](#).
- 4 Replace the [wireless card](#).
- 5 Replace the [memory modules](#).
- 6 Follow the procedure from step 4 to step 6 in "[Replacing the hard drive](#)".
- 7 Replace the [base cover](#).
- 8 Replace the [battery](#).

Removing the thermal-cooling assembly



WARNING: Before working inside your computer, read the safety information that shipped with your computer and follow the steps in [Before working inside your computer](#). After working inside your computer, follow the instructions in [After working inside your computer](#). For more safety best practices, see the Regulatory Compliance home page at www.dell.com/regulatory_compliance.

Prerequisites

- 1 Remove the [battery](#).
- 2 Remove the [base cover](#).
- 3 Follow the procedure from step 1 to step 3 in "[Removing the hard drive](#)".
- 4 Remove the [memory modules](#).
- 5 Remove the [wireless card](#).
- 6 Remove the [keyboard](#).
- 7 Follow the procedure from step 1 to step 8 in "[Removing the palm rest](#)".
- 8 Follow the procedure from step 1 to step 6 in "[Removing the system board](#)".

Procedure

- 1 In sequential order (as indicated on the thermal-cooling assembly), loosen the captive screws that secure the thermal-cooling assembly to the system board.
- 2 Disconnect the fan cable from the system board.



- 3** Lift the thermal-cooling assembly off the system board.

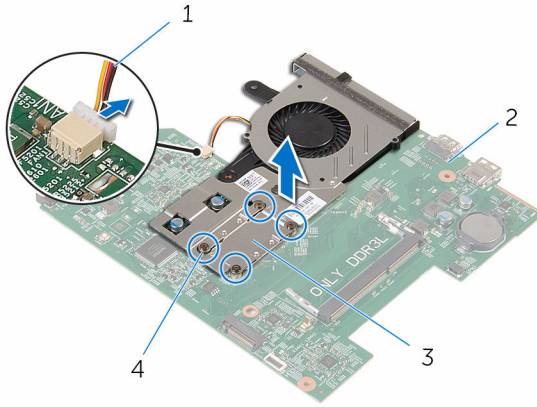

- | | | | |
|---|--------------------------|---|--------------------|
| 1 | fan cable | 2 | system board |
| 3 | thermal-cooling assembly | 4 | captive screws (4) |

- 4** Follow the procedure from step 1 to step 3 in "[Removing the fan](#)".

Replacing the thermal-cooling assembly



WARNING: Before working inside your computer, read the safety information that shipped with your computer and follow the steps in [Before working inside your computer](#). After working inside your computer, follow the instructions in [After working inside your computer](#). For more safety best practices, see the Regulatory Compliance home page at www.dell.com/regulatory_compliance.

Procedure

- 1 Follow procedure from step 1 to step 3 in "[Replacing the fan](#)".
- 2 Align the screws on the thermal-cooling assembly with the screw holes on the system board.
- 3 In sequential order (as indicated on the thermal-cooling assembly), tighten the captive screws that secure the thermal-cooling assembly to the system board.
- 4 Connect the fan cable to the system board.

Post-requisites

- 1 Follow the procedure from step 3 to step 8 in "[Replacing the system board](#)".
- 2 Follow the procedure from step 4 to step 11 in "[Replacing the palm rest](#)".
- 3 Replace the [keyboard](#).
- 4 Replace the [wireless card](#).
- 5 Replace the [memory modules](#).
- 6 Follow the procedure from step 4 to step 6 in "[Replacing the hard drive](#)".
- 7 Replace the [base cover](#).
- 8 Replace the [battery](#).



Removing the fan



WARNING: Before working inside your computer, read the safety information that shipped with your computer and follow the steps in [Before working inside your computer](#). After working inside your computer, follow the instructions in [After working inside your computer](#). For more safety best practices, see the Regulatory Compliance home page at www.dell.com/regulatory_compliance.

Prerequisites

- 1 Remove the [battery](#).
- 2 Remove the [base cover](#).
- 3 Follow the procedure from step 1 to step 3 in "[Removing the hard drive](#)".
- 4 Remove the [memory modules](#).
- 5 Remove the [wireless card](#).
- 6 Remove the [keyboard](#).
- 7 Follow the procedure from step 1 to step 8 in "[Removing the palm rest](#)".
- 8 Follow the procedure from step 1 to step 6 in "[Removing the system board](#)".
- 9 Follow the procedure from step 1 to step 3 in "[Removing the thermal cooling assembly](#)".

Procedure

- 1 Remove the screws that secure the fan to the thermal-cooling assembly.

2 Turn the thermal-cooling assembly over.

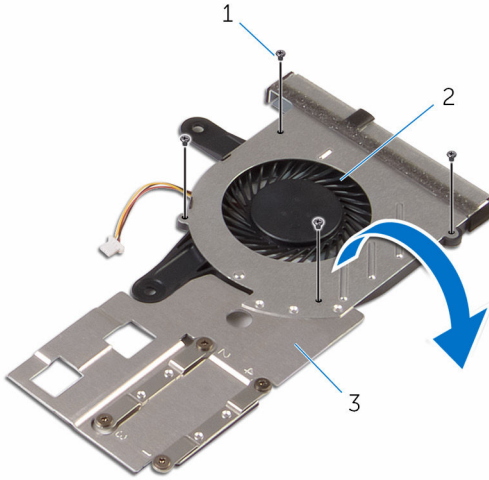

1 screws (4)

2 fan

3 thermal-cooling assembly

3 Lift the fan off the thermal-cooling assembly.

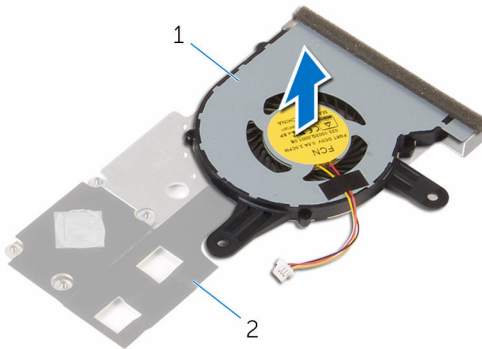

1 fan

2 thermal-cooling assembly



Replacing the fan



WARNING: Before working inside your computer, read the safety information that shipped with your computer and follow the steps in [Before working inside your computer](#). After working inside your computer, follow the instructions in [After working inside your computer](#). For more safety best practices, see the Regulatory Compliance home page at www.dell.com/regulatory_compliance.

Procedure

- 1 Place the fan on the thermal-cooling assembly.
- 2 Turn the thermal-cooling assembly over.
- 3 Replace the screws that secure the fan to the thermal-cooling assembly.

Post-requisites

- 1 Follow the procedure from step 2 to step 4 in "[Replacing the thermal-cooling assembly](#)".
- 2 Follow the procedure from step 3 to step 8 in "[Replacing the system board](#)".
- 3 Follow the procedure from step 4 to step 11 in "[Replacing the palm rest](#)".
- 4 Replace the [keyboard](#).
- 5 Replace the [wireless card](#).
- 6 Replace the [memory modules](#).
- 7 Follow the procedure from step 4 to step 6 in "[Replacing the hard drive](#)".
- 8 Replace the [base cover](#).
- 9 Replace the [battery](#).

Removing the display assembly



WARNING: Before working inside your computer, read the safety information that shipped with your computer and follow the steps in [Before working inside your computer](#). After working inside your computer, follow the instructions in [After working inside your computer](#). For more safety best practices, see the Regulatory Compliance home page at www.dell.com/regulatory_compliance.

Prerequisites

- 1 Remove the [battery](#).
- 2 Remove the [base cover](#).
- 3 Follow the procedure from step 1 to step 3 in "[Removing the hard drive](#)".
- 4 Remove the [memory modules](#).
- 5 Remove the [wireless card](#).
- 6 Remove the [keyboard](#).
- 7 Follow the procedure from step 1 to step 8 in "[Removing the palm rest](#)".
- 8 Follow the procedure from step 1 to step 5 in "[Removing the system board](#)".

Procedure

- 1 Close the display and turn the computer over.



- 2 Slide the antenna cables into the slot on the computer base.

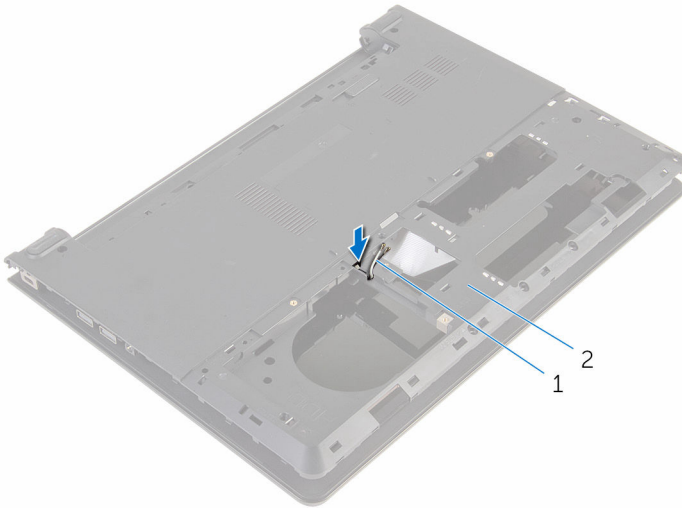

1 antenna cables (2)

2 computer base

- 3 Turn the computer over and open the display.
- 4 Lift the latch and disconnect the I/O-board cable from the I/O board.

- 5** Remove the I/O-board cable from the computer base.

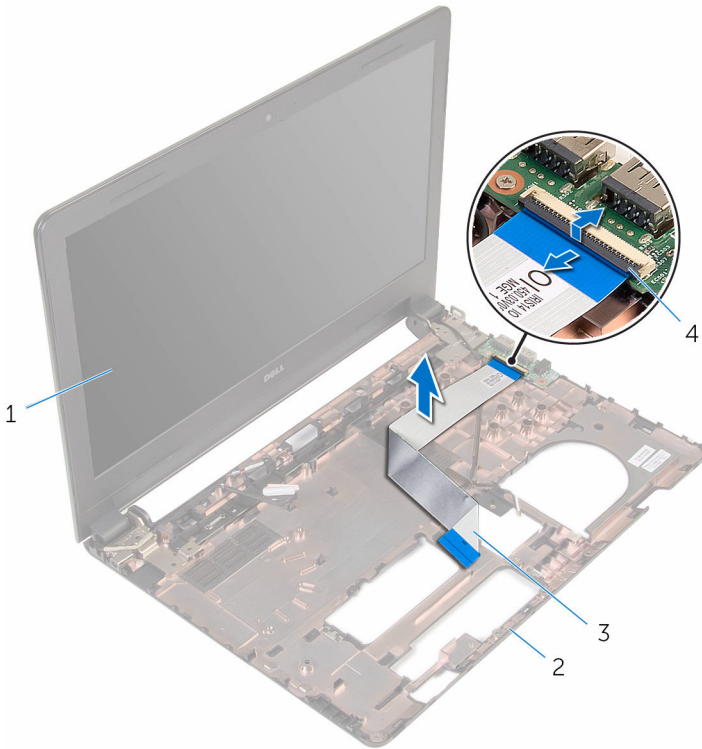

- | | | | |
|---|------------------|---|---------------|
| 1 | display assembly | 2 | computer base |
| 3 | I/O-board cable | 4 | latch |

- 6** Note the antenna cable routing and remove the antenna cable from its routing guides on the computer base.



- 7** Note the display cable routing and remove the display cable from its routing guides on the computer base.

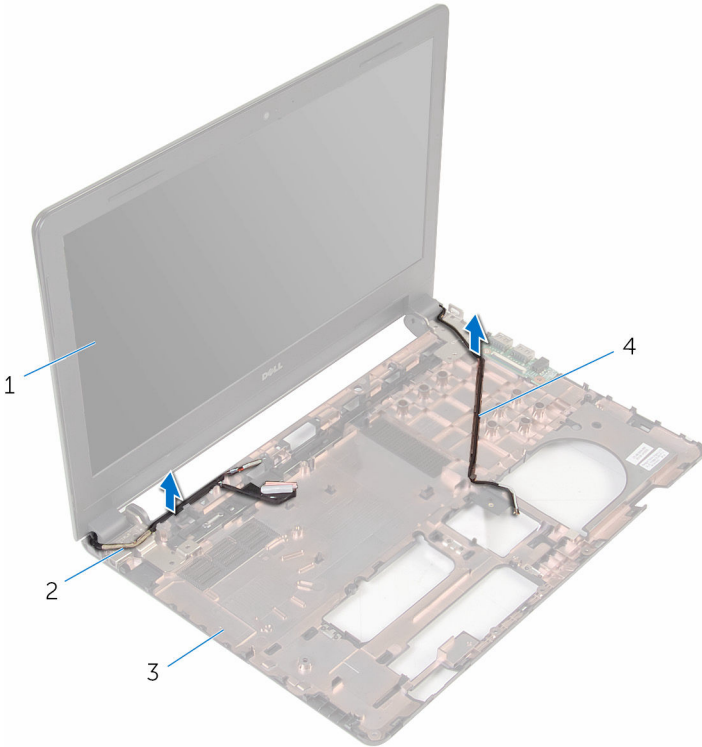

- 1 display assembly
3 computer base

- 2 display cable
4 antenna cables (2)

- 8** Remove the screws that secure the display hinges to the computer base.

9 Lift the display assembly off the computer base.

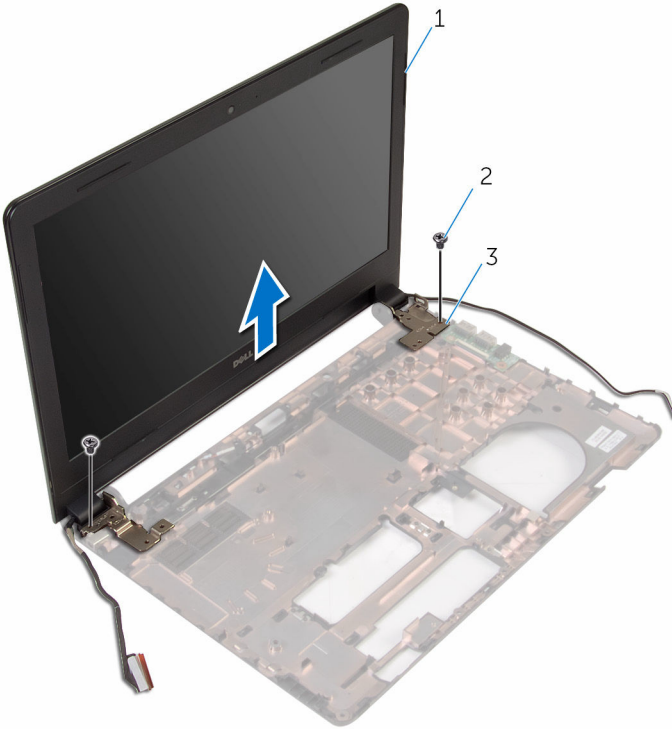

- 1 display assembly
- 3 hinges (2)

- 2 screws (2)



Replacing the display assembly



WARNING: Before working inside your computer, read the safety information that shipped with your computer and follow the steps in [Before working inside your computer](#). After working inside your computer, follow the instructions in [After working inside your computer](#). For more safety best practices, see the Regulatory Compliance home page at www.dell.com/regulatory_compliance.

Procedure

- 1 Align the screw holes on the display hinges with the screw holes on the computer base.
- 2 Replace the screws that secure the display hinges to the computer base.
- 3 Route the display cable through the routing guides on the computer base.
- 4 Route the antenna cables through the routing guides on the computer base and slide the antenna cables through the slot on the computer base.
- 5 Slide the I/O-board cable into the I/O board and press down on the latch to secure the cable.

Post-requisites

- 1 Follow the procedure from step 4 to step 8 in "[Replacing the system board](#)".
- 2 Follow the procedure from step 4 to step 11 in "[Replacing the palm rest](#)".
- 3 Replace the [keyboard](#).
- 4 Replace the [wireless card](#).
- 5 Replace the [memory modules](#).
- 6 Follow the procedure from step 4 to step 6 in "[Replacing the hard drive](#)".
- 7 Replace the [base cover](#).
- 8 Replace the [battery](#).

Removing the display bezel



WARNING: Before working inside your computer, read the safety information that shipped with your computer and follow the steps in [Before working inside your computer](#). After working inside your computer, follow the instructions in [After working inside your computer](#). For more safety best practices, see the Regulatory Compliance home page at www.dell.com/regulatory_compliance.

Prerequisites

- 1 Remove the [battery](#).
- 2 Remove the [base cover](#).
- 3 Follow the procedure from step 1 to step 3 in "[Removing the hard drive](#)".
- 4 Remove the [memory modules](#).
- 5 Remove the [wireless card](#).
- 6 Remove the [keyboard](#).
- 7 Follow the procedure from step 1 to step 8 in "[Removing the palm rest](#)".
- 8 Follow the procedure from step 1 to step 5 in "[Removing the system board](#)".

Procedure

- 1 Using your fingertips, gently pry up the inner edges of the display bezel.



2 Lift the display bezel off the display assembly.

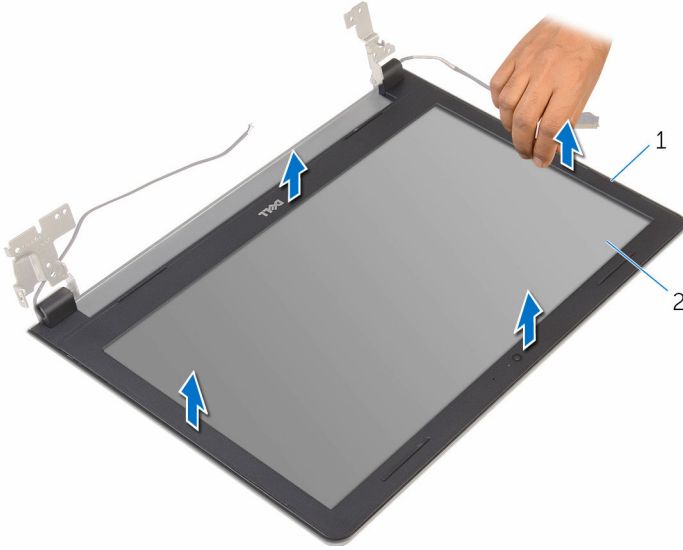

1 display bezel

2 display panel

Replacing the display bezel



WARNING: Before working inside your computer, read the safety information that shipped with your computer and follow the steps in [Before working inside your computer](#). After working inside your computer, follow the instructions in [After working inside your computer](#). For more safety best practices, see the Regulatory Compliance home page at www.dell.com/regulatory_compliance.

Procedure

Align the display bezel with the display back-cover and gently snap the display bezel into place.

Post-requisites

- 1 Replace the [display assembly](#).
- 2 Follow the procedure from step 4 to step 8 in "[Removing the system board](#)".
- 3 Follow the procedure from step 4 to step 11 in "[Removing the palm rest](#)".
- 4 Replace the [keyboard](#).
- 5 Replace the [wireless card](#).
- 6 Replace the [memory modules](#).
- 7 Follow the procedure from step 4 to step 6 in "[Replacing the hard drive](#)".
- 8 Replace the [base cover](#).
- 9 Replace the [battery](#).



Removing the display panel



WARNING: Before working inside your computer, read the safety information that shipped with your computer and follow the steps in [Before working inside your computer](#). After working inside your computer, follow the instructions in [After working inside your computer](#). For more safety best practices, see the Regulatory Compliance home page at www.dell.com/regulatory_compliance.

Prerequisites

- 1 Remove the [battery](#).
- 2 Remove the [base cover](#).
- 3 Follow the procedure from step 1 to step 3 in "[Removing the hard drive](#)".
- 4 Remove the [memory modules](#).
- 5 Remove the [wireless card](#).
- 6 Remove the [keyboard](#).
- 7 Follow the procedure from step 1 to step 8 in "[Removing the palm rest](#)".
- 8 Follow the procedure from step 1 to step 5 in "[Removing the system board](#)".
- 9 Remove the [display assembly](#).
- 10 Remove the [display bezel](#).

Procedure

- 1 Remove the screws that secure the display panel to the display back-cover.

- 4 Lift the latch and disconnect the display cable from the display-back cover.

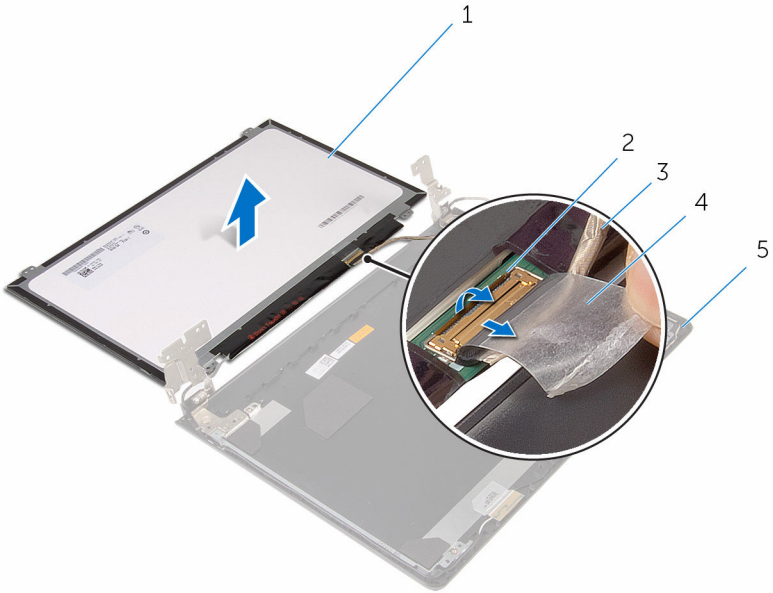

- 1 display panel
3 display cable
5 display back-cover

- 2 latch
4 tape

Replacing the display panel



WARNING: Before working inside your computer, read the safety information that shipped with your computer and follow the steps in [Before working inside your computer](#). After working inside your computer, follow the instructions in [After working inside your computer](#). For more safety best practices, see the Regulatory Compliance home page at www.dell.com/regulatory_compliance.

Procedure

- 1 Place the display panel face down on a clean and flat surface.
- 2 Slide the display cable into the display panel and press down on the latch to secure the cable.
- 3 Adhere the tape that secures the display cable to the display back-cover.
- 4 Turn the display panel over.
- 5 Align the screw holes on the display panel with the screw holes on the display back-cover.
- 6 Replace the screws that secure the display panel to the display back-cover.

Post-requisites

- 1 Replace the [display bezel](#).
- 2 Replace the [display assembly](#).
- 3 Follow the procedure from step 4 to step 8 in "[Replacing the system board](#)".
- 4 Follow the procedure from step 4 to step 11 in "[Replacing the palm rest](#)".
- 5 Replace the [keyboard](#).
- 6 Replace the [wireless card](#).
- 7 Replace the [memory modules](#).
- 8 Follow the procedure from step 4 to step 6 in "[Replacing the hard drive](#)".
- 9 Replace the [base cover](#).
- 10 Replace the [battery](#).



Removing the display hinges



WARNING: Before working inside your computer, read the safety information that shipped with your computer and follow the steps in [Before working inside your computer](#). After working inside your computer, follow the instructions in [After working inside your computer](#). For more safety best practices, see the Regulatory Compliance home page at www.dell.com/regulatory_compliance.

Prerequisites

- 1 Remove the [battery](#).
- 2 Remove the [base cover](#).
- 3 Follow the procedure from step 1 to step 3 in "[Removing the hard drive](#)".
- 4 Remove the [memory modules](#).
- 5 Remove the [wireless card](#).
- 6 Remove the [keyboard](#).
- 7 Follow the procedure from step 1 to step 8 in "[Removing the palm rest](#)".
- 8 Follow the procedure from step 1 to step 5 in "[Removing the system board](#)".
- 9 Remove the [display assembly](#).
- 10 Remove the [display bezel](#).
- 11 Remove the [display panel](#).

Procedure

- 1 Remove the screws that secure the display hinges to the display back-cover.

2 Lift the display hinges off the display back-cover.

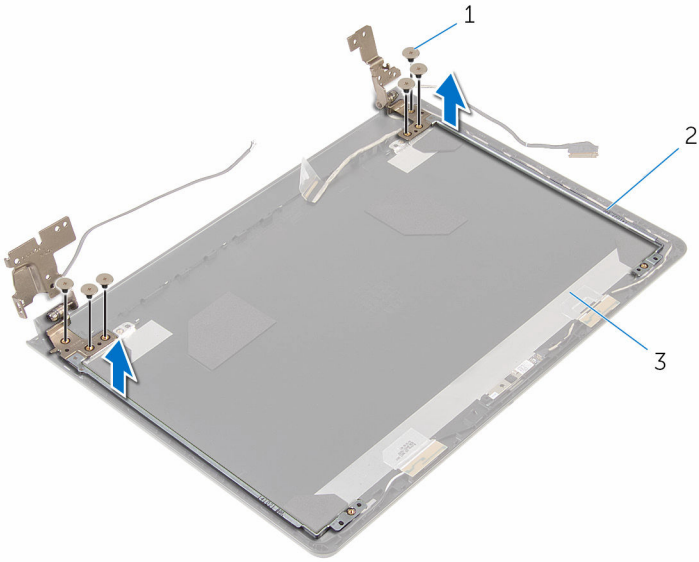

1 screws (6)

2 display hinges (2)

3 display back-cover



Replacing the display hinges



WARNING: Before working inside your computer, read the safety information that shipped with your computer and follow the steps in [Before working inside your computer](#). After working inside your computer, follow the instructions in [After working inside your computer](#). For more safety best practices, see the Regulatory Compliance home page at www.dell.com/regulatory_compliance.

Procedure

- 1 Align the screw holes on the display hinges with the screw holes on the display back-cover.
- 2 Replace the screws that secure the display hinges to the display back-cover.

Post-requisites

- 1 Replace the [display panel](#).
- 2 Replace the [display bezel](#).
- 3 Replace the [display assembly](#).
- 4 Follow the procedure from step 4 to step 8 in "[Replacing the system board](#)".
- 5 Follow the procedure from step 4 to step 11 in "[Replacing the palm rest](#)".
- 6 Replace the [keyboard](#).
- 7 Replace the [wireless card](#).
- 8 Replace the [memory modules](#).
- 9 Follow the procedure from step 4 to step 6 in "[Replacing the hard drive](#)".
- 10 Replace the [base cover](#).
- 11 Replace the [battery](#).

Removing the display back-cover



WARNING: Before working inside your computer, read the safety information that shipped with your computer and follow the steps in [Before working inside your computer](#). After working inside your computer, follow the instructions in [After working inside your computer](#). For more safety best practices, see the Regulatory Compliance home page at www.dell.com/regulatory_compliance.

Prerequisites

- 1 Remove the [battery](#).
- 2 Remove the [base cover](#).
- 3 Follow the procedure from step 1 to step 3 in "[Removing the hard drive](#)".
- 4 Remove the [memory modules](#).
- 5 Remove the [wireless card](#).
- 6 Remove the [keyboard](#).
- 7 Follow the procedure from step 1 to step 8 in "[Removing the palm rest](#)".
- 8 Follow the procedure from step 1 to step 5 in "[Removing the system board](#)".
- 9 Remove the [display bezel](#).
- 10 Remove the [display assembly](#).
- 11 Remove the [display panel](#).
- 12 Remove the [display hinges](#).

Procedure

After removing all the parts in the prerequisites, we are left with the display back-cover.



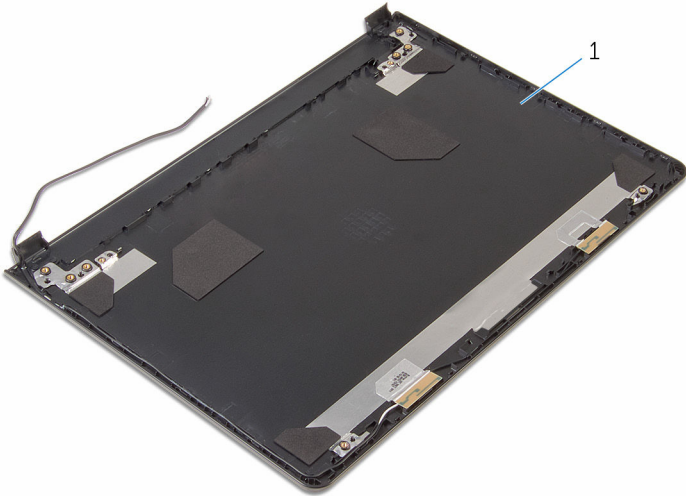

1 display back-cover

Replacing the display back-cover



WARNING: Before working inside your computer, read the safety information that shipped with your computer and follow the steps in [Before working inside your computer](#). After working inside your computer, follow the instructions in [After working inside your computer](#). For more safety best practices, see the Regulatory Compliance home page at www.dell.com/regulatory_compliance.

Procedure

Place the display back-cover on a clean and flat surface.

Post-requisites

- 1 Replace the [display hinges](#).
- 2 Replace the [display bezel](#).
- 3 Replace the [display panel](#).
- 4 Replace the [display assembly](#).
- 5 Follow the procedure from step 4 to step 8 in "[Replacing the system board](#)".
- 6 Follow the procedure from step 4 to step 11 in "[Replacing the palm rest](#)".
- 7 Replace the [keyboard](#).
- 8 Replace the [wireless card](#).
- 9 Replace the [memory modules](#).
- 10 Follow the procedure from step 4 to step 6 in "[Replacing the hard drive](#)".
- 11 Replace the [base cover](#).
- 12 Replace the [battery](#).



Removing the camera



WARNING: Before working inside your computer, read the safety information that shipped with your computer and follow the steps in [Before working inside your computer](#). After working inside your computer, follow the instructions in [After working inside your computer](#). For more safety best practices, see the Regulatory Compliance home page at www.dell.com/regulatory_compliance.

Prerequisites

- 1 Remove the [battery](#).
- 2 Remove the [base cover](#).
- 3 Follow the procedure from step 1 to step 3 in "[Removing the hard drive](#)".
- 4 Remove the [memory modules](#).
- 5 Remove the [wireless card](#).
- 6 Remove the [keyboard](#).
- 7 Follow the procedure from step 1 to step 8 in "[Removing the palm rest](#)".
- 8 Follow the procedure from step 1 to step 5 in "[Removing the system board](#)".
- 9 Remove the [display assembly](#).
- 10 Remove the [display bezel](#).

Procedure

- 1 Note the location of the camera and, using a plastic scribe, carefully pry the camera off the display back-cover.

- 2** Disconnect the camera cable from the camera and remove the camera from the display-back cover.

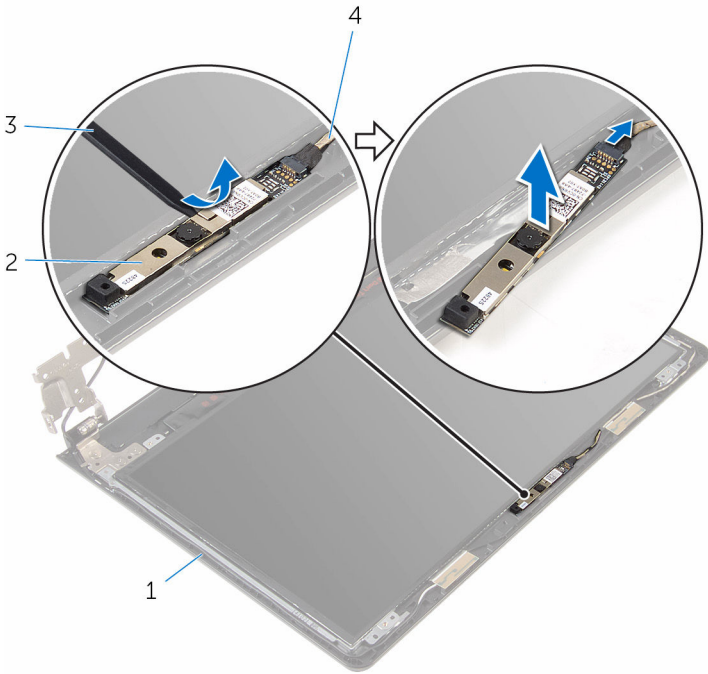

- 1 display back-cover
3 plastic scribe

- 2 camera
4 camera cable



Replacing the camera



WARNING: Before working inside your computer, read the safety information that shipped with your computer and follow the steps in [Before working inside your computer](#). After working inside your computer, follow the instructions in [After working inside your computer](#). For more safety best practices, see the Regulatory Compliance home page at www.dell.com/regulatory_compliance.

Procedure

- 1 Connect the camera cable to the camera.
- 2 Adhere the camera to the display back-cover.

Post-requisites

- 1 Replace the [display bezel](#).
- 2 Replace the [display assembly](#).
- 3 Follow the procedure from step 4 to step 8 in "[Replacing the system board](#)".
- 4 Follow the procedure from step 4 to step 11 in "[Replacing the palm rest](#)".
- 5 Replace the [keyboard](#).
- 6 Replace the [wireless card](#).
- 7 Replace the [memory modules](#).
- 8 Follow the procedure from step 4 to step 6 in "[Replacing the hard drive](#)".
- 9 Replace the [base cover](#).
- 10 Replace the [battery](#).

Removing the power-adapter port



WARNING: Before working inside your computer, read the safety information that shipped with your computer and follow the steps in [Before working inside your computer](#). After working inside your computer, follow the instructions in [After working inside your computer](#). For more safety best practices, see the Regulatory Compliance home page at www.dell.com/regulatory_compliance.

Prerequisites

- 1 Remove the [battery](#).
- 2 Remove the [base cover](#).
- 3 Follow the procedure from step 1 to step 3 in "[Removing the hard drive](#)".
- 4 Remove the [memory modules](#).
- 5 Remove the [wireless card](#).
- 6 Remove the [keyboard](#).
- 7 Follow the procedure from step 1 to step 8 in "[Removing the palm rest](#)".
- 8 Follow the procedure from step 1 to step 5 in "[Removing the system board](#)".
- 9 Remove the [display assembly](#).

Procedure

- 1 Note the power-adapter port cable routing and remove the cable from the routing guides on the computer base.
- 2 Remove the screw that secures the power-adapter port to the computer base.



- 3** Lift the power-adaptor port along with the cable off the computer base.

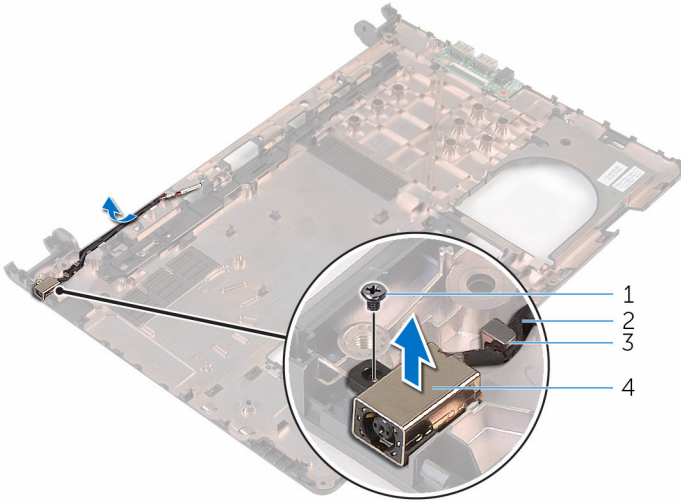

1 screw

2 power-adaptor port cable

3 routing guide

4 power-adaptor port

Replacing the power-adapter port



WARNING: Before working inside your computer, read the safety information that shipped with your computer and follow the steps in [Before working inside your computer](#). After working inside your computer, follow the instructions in [After working inside your computer](#). For more safety best practices, see the Regulatory Compliance home page at www.dell.com/regulatory_compliance.

Procedure

- 1 Slide the power-adapter port into the slot on the computer base.
- 2 Replace the screw that secures the power-adapter port to the computer base.
- 3 Route the power-adapter port cable through the routing guides on the computer base.

Post-requisites

- 1 Replace the [display assembly](#).
- 2 Follow the procedure from step 4 to step 8 in "[Replacing the system board](#)".
- 3 Follow the procedure from step 4 to step 11 in "[Replacing the palm rest](#)".
- 4 Replace the [keyboard](#).
- 5 Replace the [wireless card](#).
- 6 Replace the [memory modules](#).
- 7 Follow the procedure from step 4 to step 6 in "[Replacing the hard drive](#)".
- 8 Replace the [base cover](#).
- 9 Replace the [battery](#).



Removing the computer base



WARNING: Before working inside your computer, read the safety information that shipped with your computer and follow the steps in [Before working inside your computer](#). After working inside your computer, follow the instructions in [After working inside your computer](#). For more safety best practices, see the Regulatory Compliance home page at www.dell.com/regulatory_compliance.

Prerequisites

- 1 Remove the [battery](#).
- 2 Remove the [base cover](#).
- 3 Follow the procedure from step 1 to step 3 in "[Removing the hard drive](#)".
- 4 Remove the [memory modules](#).
- 5 Remove the [wireless card](#).
- 6 Remove the [keyboard](#).
- 7 Follow the procedure from step 1 to step 8 in "[Removing the palm rest](#)".
- 8 Follow the procedure from step 1 to step 6 in "[Removing the system board](#)".
- 9 Follow the procedure from step 1 to step 3 in "[Removing the thermal cooling assembly](#)".
- 10 Follow the procedure from step 1 to step 3 in "[Removing the I/O board](#)".
- 11 Remove the [display assembly](#).
- 12 Follow the procedure from step 1 to step 3 in "[Removing the power-adaptor port](#)".

Procedure

After removing all the parts in the prerequisites, we are left with the computer base.

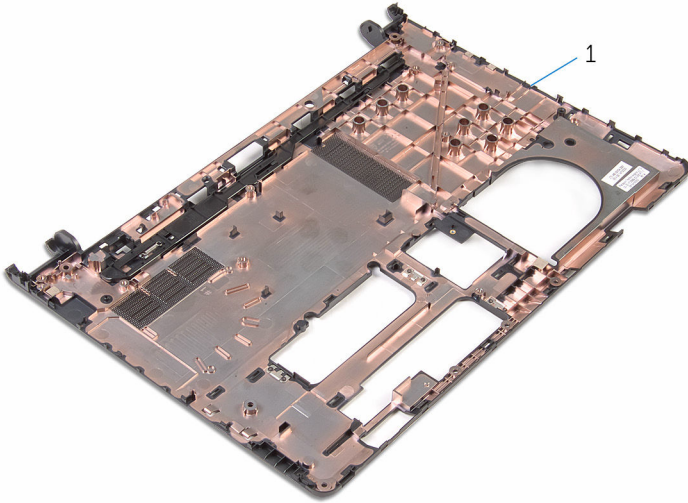

1 computer base

Replacing the computer base



WARNING: Before working inside your computer, read the safety information that shipped with your computer and follow the steps in [Before working inside your computer](#). After working inside your computer, follow the instructions in [After working inside your computer](#). For more safety best practices, see the Regulatory Compliance home page at www.dell.com/regulatory_compliance.

Procedure

Place the computer base on a clean and flat surface.

Post-requisites

- 1 Follow the procedure from step 1 to step 3 in "[Replacing the power-adaptor port](#)".
- 2 Replace the [display assembly](#).
- 3 Follow the procedure from step 1 to step 3 in "[Replacing the I/O board](#)".
- 4 Follow the procedure from step 2 to step 4 in "[Replacing the thermal-cooling assembly](#)".
- 5 Follow the procedure from step 4 to step 8 in "[Replacing the system board](#)".
- 6 Follow the procedure from step 4 to step 11 in "[Replacing the palm rest](#)".
- 7 Replace the [keyboard](#).
- 8 Replace the [wireless card](#).
- 9 Replace the [memory modules](#).
- 10 Follow the procedure from step 4 to step 6 in "[Replacing the hard drive](#)".
- 11 Replace the [base cover](#).
- 12 Replace the [battery](#).

Flashing the BIOS

You may need to flash (update) the BIOS when an update is available or when you replace the system board. To flash the BIOS:

- 1 Turn on your computer.
- 2 Go to www.dell.com/support.
- 3 Click **Product support**, enter the Service Tag of your computer, and then click **Submit**.



NOTE: If you do not have the Service Tag, use the auto-detect feature or manually browse for your computer model.

- 4 Click **Drivers & downloads** → **Find it myself**.
- 5 Select the operating system installed on your computer.
- 6 Scroll down the page and expand **BIOS**.
- 7 Click **Download** to download the latest version of the BIOS for your computer.
- 8 After the download is complete, navigate to the folder where you saved the BIOS update file.
- 9 Double-click the BIOS update file icon and follow the instructions on the screen.



Getting help and contacting Dell

Self-help resources

You can get information and help on Dell products and services using these self-help resources:

Information about Dell products and services

www.dell.com

Windows 8.1 and Windows 10

Dell Help & Support app



Windows 10

Get started app



Windows 8.1

Help + Tips app



Accessing help in Windows 8, Windows 8.1, and Windows 10

In Windows search, type **Help and Support**, and press Enter.

Accessing help in Windows 7

Click **Start** → **Help and Support**.

Online help for operating system

www.dell.com/support/windows

www.dell.com/support/linux

Troubleshooting information, user manuals, setup instructions, product specifications, technical help blogs, drivers, software updates, and so on.

www.dell.com/support

Learn about your operating system, setting up and using your computer, data backup, diagnostics, and so on.

See *Me and My Dell* at www.dell.com/support/manuals.

Contacting Dell

To contact Dell for sales, technical support, or customer service issues, see www.dell.com/contactdell.



NOTE: Availability varies by country and product, and some services may not be available in your country.



NOTE: If you do not have an active internet connection, you can find contact information on your purchase invoice, packing slip, bill, or Dell product catalog.

